



The Optimum Solution for Dairies

Unique PMO-F Mixproof Valve

Compliance

- Meets 3A/PMO Requirements Compliance with O.D. Balancer Cleaning

Concept

This Unique **PMO-F** Mixproof valve is based on the well proven and exceptionally flexible design of the Unique Mixproof valves from Alfa Laval. It meets the demands from the 3A/PMO (Pasteurized Milk Ordinance paragraph 15p(B)) standards saying that all movements have to be detectable, as well as the vent tube has to have the same or greater area than the connection pipe. Furthermore, the actuator is fail safe by spring to close. Compliance with 3A/PMO allows a pasteurized milk product to be in one chamber while CIP solution is in the other chamber.

Working Principle

Unique **PMO-F** is remote-controlled by means of compressed air. The valve is a normally closed (NC) valve.

The valve has two independent plug seals, forming a leakage chamber between them which is at atmospheric pressure or less during every working condition. In the rare case of fluid passing a valve seat, the fluid will enter the leakage chamber and be discharged through the leakage outlet. When the valve is open, the leakage chamber is closed.

Build-up

This **PMO-F** edition of the Unique Mixproof valve is a high-end valve with regards to process security as well as from a sanitary point of view. The valve plugs are always balanced in both upper and lower valve body, securing no sensitivity to pressure spikes.

The lower and upper seats are position-detectable by the ThinkTop® and a yoke-mounted, external sensor.

The Unique **PMO-F** Mixproof valve is provided with an O.D. balancer cleaning element which allows cleaning of the outside soiled area of the lower seat balancer during a lower seat push operation. The Unique **PMO-F** Mixproof valve is available in 1½" - 6" tube O.D. sizes.



Unique PMO-F Mixproof Valve with externally mounted indication.

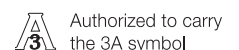
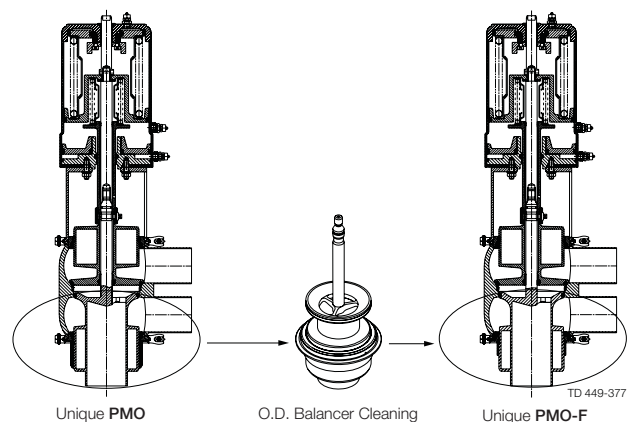

Dimensions [Inches]

Size	1½"	2"	2.5"	3"	4"	6"
A	19.232	22.559	25.709	26.929	30.748	39.449
A*	26.319	29.646	32.795	34.016	37.835	46.535
B	6.693	8.661	11.811	11.811	11.811	17.323
**C	2.394	2.906	3.398	3.894	4.866	6.798
OD	1.500	2.008	2.500	2.996	4.000	6.000
ID	1.370	1.882	2.374	2.870	3.843	5.782
t	0.063	0.063	0.063	0.063	0.079	0.109
E	2.925	4.488	4.961	5.472	6.535	8.298
F1	1.240	1.240	1.496	1.496	2.323	2.953
F2	0.197	0.197	0.197	0.197	0.197	0.197
øD	4.724	4.724	6.181	6.181	7.323	7.323
L	9.055	9.055	9.921	9.921	11.063	14.921
M/Tri-clamp	0.827	0.827	0.827	0.827	0.827	1.518
Weight (lb)	33.000	33.000	53.000	53.000	75.000	176.500

NOTE!

**The measure C can always be calculated by the formula

$$C = \frac{1}{2}ID_{\text{upper}} + \frac{1}{2}ID_{\text{lower}} + 1''.$$

Valve body combinations

Type 11-00

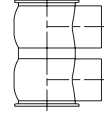

Type 11-90

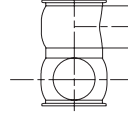

Type 11-180

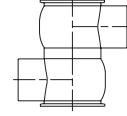

Type 11-270

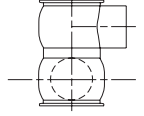

Type 12-00

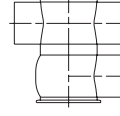

Type 12-90

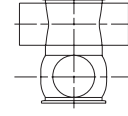

Type 21-00

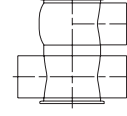

Type 21-90

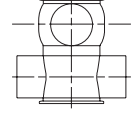

Type 22-00

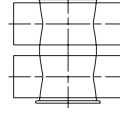

Type 22-90

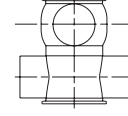

TD 449-014_1

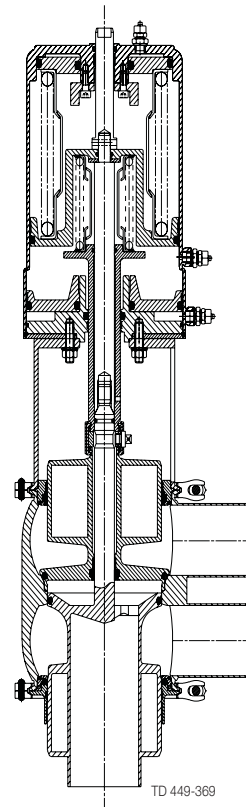
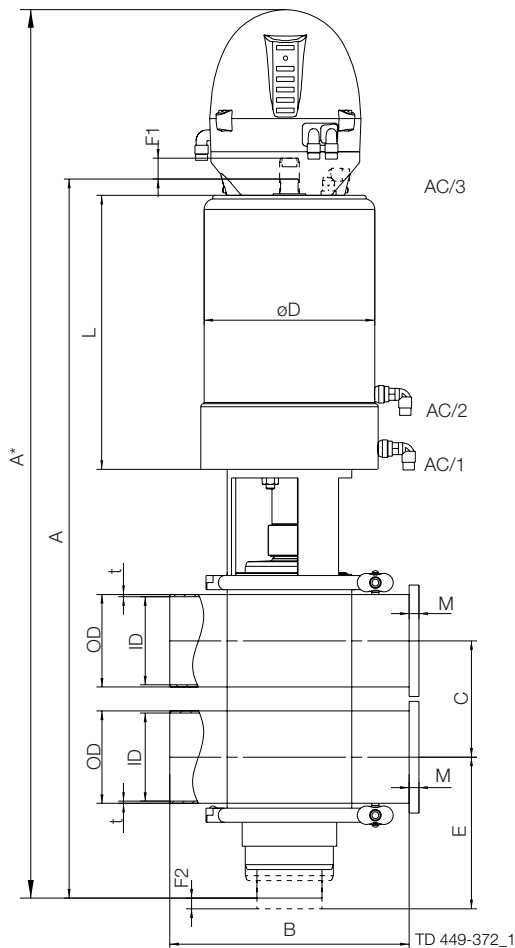

Fig. 1 Details of Unique PMO-F Mixproof Valve

Pressure drop/capacity diagrams

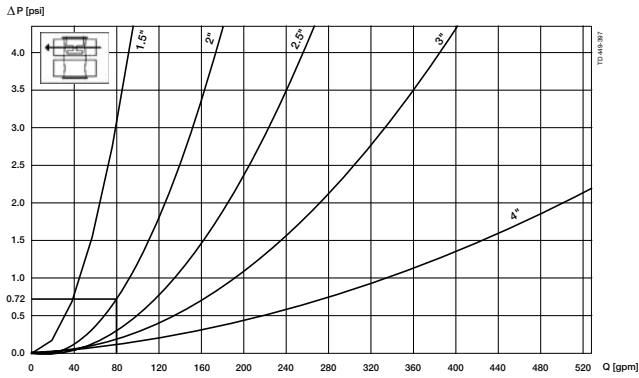

Fig. 2. Pressure drop/capacity diagram, upper bodies.

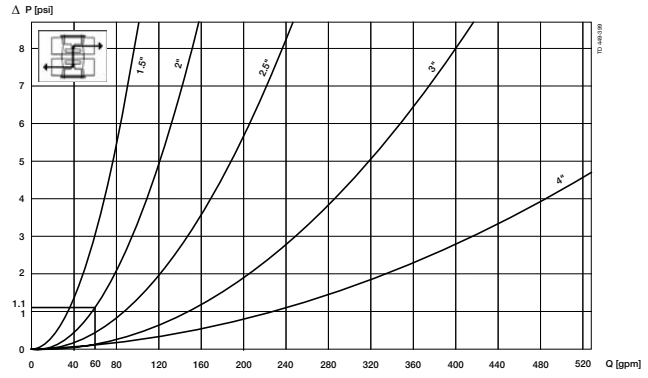

Fig. 3. Pressure drop/capacity diagram, between bodies.

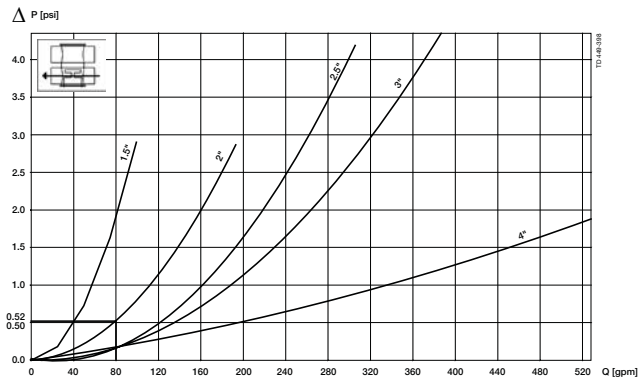

Fig. 4. Pressure drop/capacity diagram, lower body.

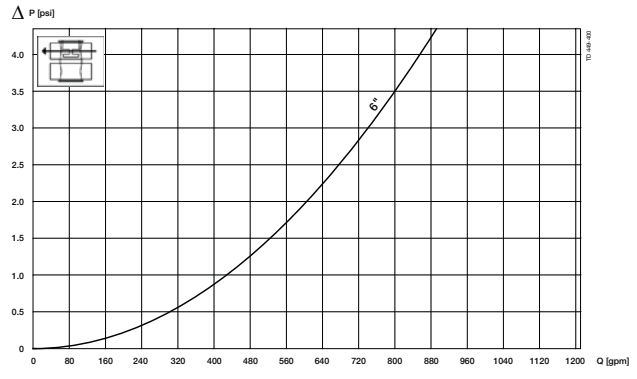

Fig. 5. Pressure drop/capacity diagram, upper bodies.

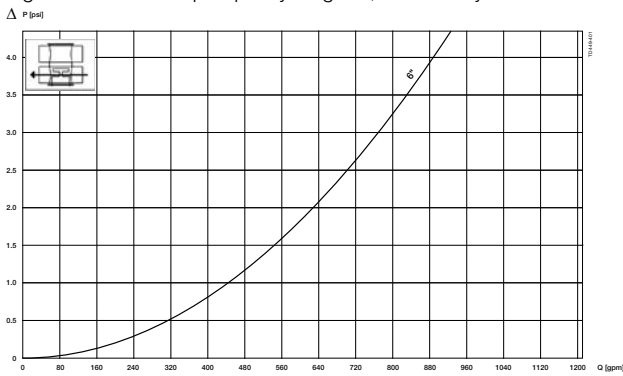

Fig. 6. Pressure drop/capacity diagram, lower body.

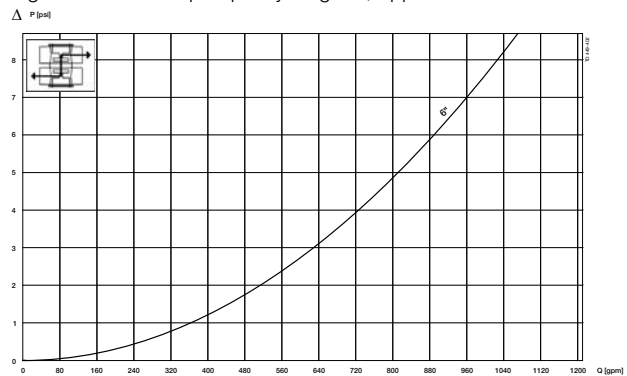

Fig. 7. Pressure drop/capacity diagram, between bodies.

Example to determine pressure drop at a given flow rate:

Upper body size: 2". Capacity = 80 gpm.
 Lower body size: 2". Capacity = 80 gpm.
 Between bodies: 2". Capacity = 60 gpm.

Note!

For the diagrams the following applies:
 Medium: Water (68°F).
 Measurement: In accordance with VDI 2173.

Result:

From fig. 2, $\Delta p = 0.72$ psi through upper body.

From fig. 3, $\Delta p = 1.1$ psi between bodies.

From fig. 4, $\Delta p = 0.52$ psi through lower body.

Technical Data

Max. product pressure:145 psi (for higher pressure, please ask Alfa Laval)
 Min. product pressure:Full vacuum.
 Temperature range:23°F to +257°F (Depending on elastomer type)
 (For higher temperatures, please contact Alfa Laval)
 Air pressure:Max. 116 psi.

Size	OD 1½"	OD 2"	OD 2½"	OD 3"	OD 4"	OD 6"
Cv-value Upper Seat-lift [gpm/psi]	1.7	2.6	3.9	3.9	5.3	12.1
Cv-value Lower Seat-lift [gpm/psi]	2.2	4.5	5.9	5.9	7.5	17.1
Air consumption Upper Seat-lift * [cubic inches]	12	12	24	24	38	38
Air consumption Lower Seat-lift * [cubic inches]	67	67	8	8	13	13
Air consumption Main Movement * [cubic inches]	52	52	99	99	170	216

$$Q = Cv \cdot \sqrt{\Delta p}$$

Q = water flow [gpm]

Cv = value from the above table.

Δp = water pressure [psi]

Materials

Product wetted steel parts:Acid-resistant steel AISI 316L
 Other steel parts:Stainless steel AISI 304
 Product wetted parts:EPDM (std.) NBR, HNBR or FPM
 Other seals:CIP seals: EPDM.
 Actuator seals: NBR.
 Surface finish:External bright/internal polished Ra<32μ"

Ordering

For ordering, contact Alfa Laval.

Control & Indication for both upper and lower seat lift as well as main movement, is given via the ThinkTop® control unit.
 Please refer to ESE00521 ENUS, ESE00299 ENUS and ESE00298 ENUS for further information.

Alfa Laval reserves the right to change specifications without prior notification. ALFA LAVAL is a trademark registered and owned by Alfa Laval Corporate AB.

ESE00794US 1103

© Alfa Laval

How to contact Alfa Laval

Contact details for all countries are continually updated on our website. Please visit www.alfalaval.us to access the information direct.

 Authorized to carry the 3A symbol